

## Características

- Hasta 84% ahorro de energía
- Alta salida de luz, hasta 775lm
- Alto IRC, 83Ra
- Dimable



## Información Eléctrica

Model No.	P1427E25T3B	P1427E40T3B	P1440E25T3B	P1440E40T3B
Potencia	14.4 W	14.4 W	14.4 W	14.4 W
Equiv. Lamp convencional	80 W	80 W	90 W	90 W
Frecuencia de operación	50/60 Hz	50/60 Hz	50/60 Hz	50/60 Hz
Tensión	220-240 V	220-240 V	220-240 V	220-240 V
Factor de potencia	>0.9	>0.9	>0.9	>0.9

## Información Técnica

Model No.	P1427E25T3B	P1427E40T3B	P1440E25T3B	P1440E40T3B
Ángulo de apertura	25 °	40 °	25 °	40 °
Flujo luminoso	700 lm	700 lm	775 lm	775 lm
Eficacia luminosa	<b>48,5 lm</b>	<b>48,5 lm</b>	<b>53,5 lm</b>	<b>53,5 lm</b>
Temperatura de color	2.700 K	2.700 K	4.000 K	4.000 K
IRC	83 Ra	83 Ra	83 Ra	83 Ra
Duración	45.000hrs(L70)	45.000hrs(L70)	45.000hrs(L70)	45.000hrs(L70)
Dimable	Si	Si	Si	Si
Peso	300 g	300 g	300 g	300 g
Base	E27	E27	E27	E27

*NOTA! Todas las especificaciones técnicas son orientativas. Las especificaciones están sujetas a cambios sin previo aviso.*

## Dimensiones

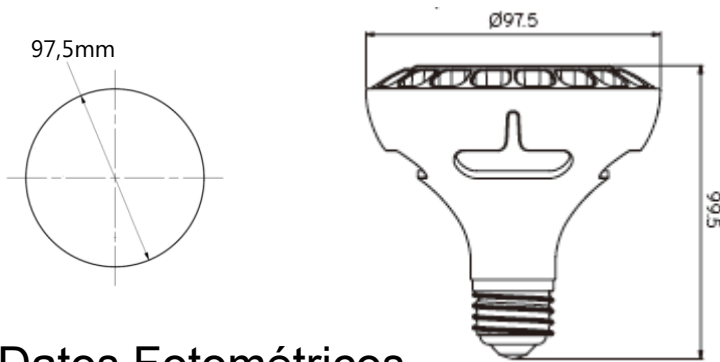

## Certificación



## Datos Fotométricos

### P1427E25T3B

Cone Lux Diagram

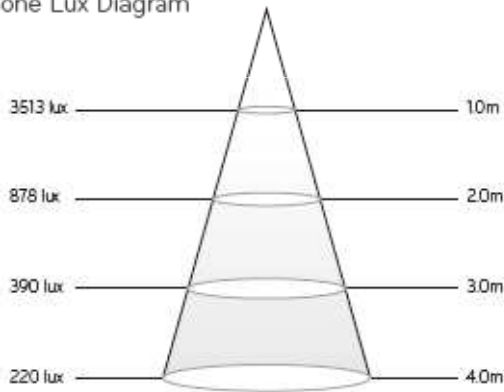

Luminance Intensity Distribution

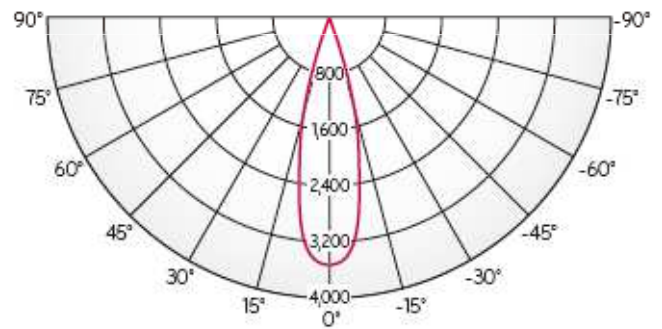

### P1427E40T3B

Cone Lux Diagram

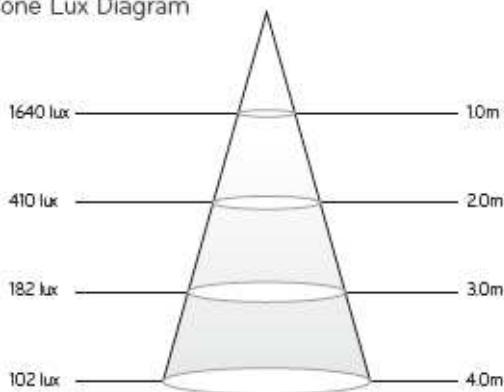

Luminance Intensity Distribution

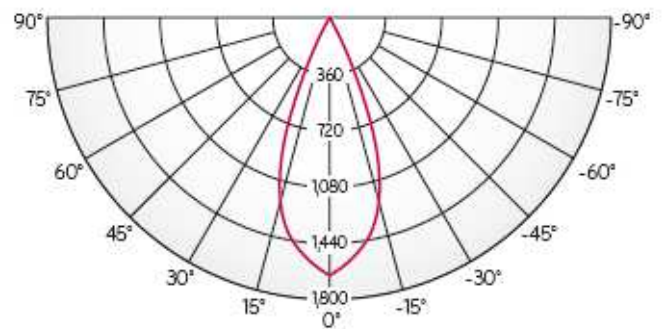

## P1440E25T3B

Cone Lux Diagram

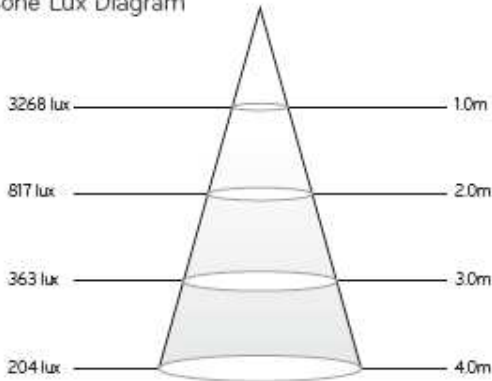

Luminance Intensity Distribution

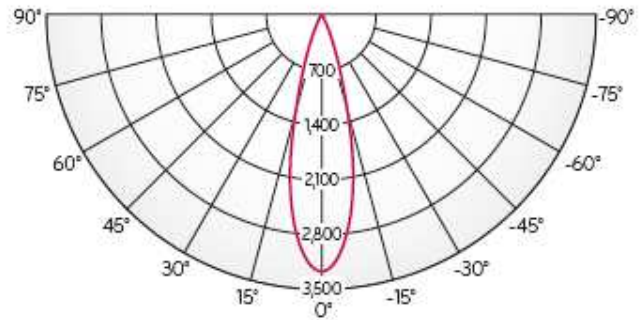

## P1440E40T3B

Cone Lux Diagram

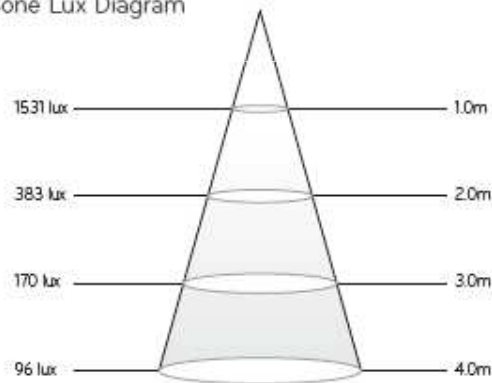

Luminance Intensity Distribution

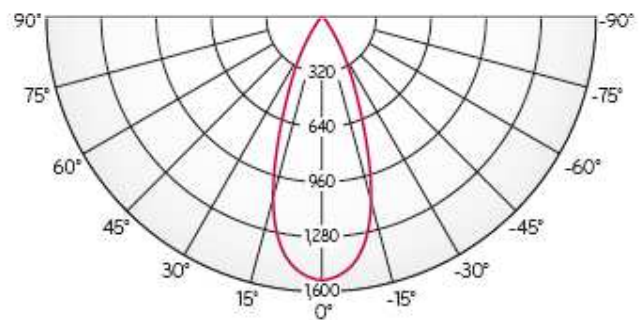

## Datos Logísticos

Model No.	EAN Code	Packing unit (Pieces/Unit)	Dimensiones (W x D x H)	Peso bruto	CBM
P1427E25T3B	8806084474926	1	98 x 98 x 129 mm	300g	
P1427E40T3B	8806084474933	1	98 x 98 x 129 mm	300g	
P1440E25T3B	8806084474940	1	98 x 98 x 129 mm	300g	
P1440E40T3B	8806084474964	1	98 x 98 x 129 mm	300g	
(Large Box)	-	20	513 x 210 x 278 mm	7400g	0.029949