

Características

- Hasta 70% ahorro de energía
- Alta salida de luz, 5.100lm
- IRC, 75Ra
- Vida útil de 50.000hrs



Información Eléctrica

Model No.	LS6075ABFBB	LS6075BBFBB	LS6076ABFBB	LS6076BBFBB
Potencia	60 W	60 W	60 W	60 W
Voltaje de entrada	100-240 V	100-240 V	100-240 V	100-240 V
Frecuencia de operación	50/60 Hz	50/60 Hz	50/60 Hz	50/60 Hz
Factor de potencia	>0.9	>0.9	>0.9	>0.9

Información Técnica

Model No.	LS6075ABFBB	LS6075BBFBB	LS6076ABFBB	LS6076BBFBB
Ángulo de apertura	TIPO I	TIPO II	TIPO I	TIPO II
Flujo luminoso	5.100 lm	5.100 lm	5.100 lm	5.100 lm
Eficiencia luminica	85 Lm/ w	85 Lm/ w	85 Lm/ w	85 Lm/ w
Temperatura color	5.000K	5.000K	5.700K	5.700K
IRC	75 Ra	75 Ra	75 Ra	75 Ra
Duración	50.000 horas	50.000 horas	50.000 horas	50.000 horas
Peso	7.1 kg	7.1 kg	7.1 kg	7.1 kg
Temperatura operación	-40 + 50°	-40 + 50°	-40 + 50°	-40 + 50°
Grado de protección	IP65	IP65	IP65	IP65

Dimensiones

Certificación

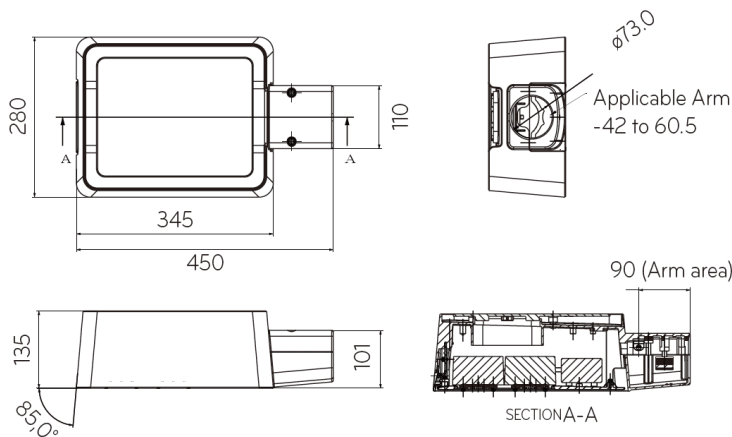

Datos Fotometricos

LS6075ABFBB / LS6076ABFBB

Isolux Diagram

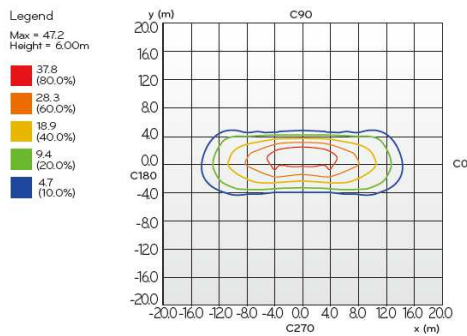

Luminance Intensity Distribution

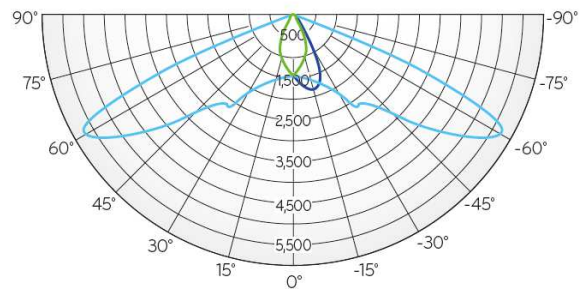

LS6075BBFBB / LS6076BBFBB

Isolux Diagram

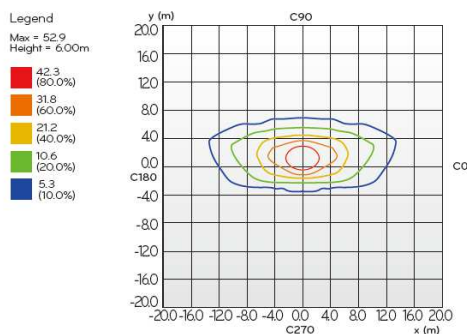

Luminance Intensity Distribution

